



**KERN**® **KERN & Sohn GmbH**

Ziegelei 1  
D-72336 Balingen  
email: [info@kern-sohn.com](mailto:info@kern-sohn.com)

Phone: +49-[0]7433- 9933-0  
Fax: +49-[0]7433-9933-149  
Internet: [www.kern-sohn.com](http://www.kern-sohn.com)

# Operating Manual

## Precision balances

### KERN PLE-N

Version 2.1  
12/2010  
GB



PLE-N-BA-e-1021



# KERN PLE-N

Version 2.1 12/2010

## Operating Manual Precision balances

### Table of Contents

|          |  |           |
|----------|--|-----------|
| <b>1</b> | <b>Technical Data</b> .....  | <b>4</b>  |
| <b>2</b> | <b>Declaration of conformity</b> .....                               | <b>5</b>  |
| <b>3</b> | <b>Basic Information (General)</b> .....                             | <b>6</b>  |
| 3.1      | Proper use.....  | 6         |
| 3.2      | Improper Use .....   | 6         |
| 3.3      | Warranty .....   | 6         |
| 3.4      | Monitoring of Test Resources .....                                   | 6         |
| <b>4</b> | <b>Basic Safety Precautions</b> .....                                | <b>7</b>  |
| 4.1      | Pay attention to the instructions in the Operation Manual.....       | 7         |
| 4.2      | Personnel training .....   | 7         |
| <b>5</b> | <b>Transportation &amp; Storage</b> .....                            | <b>7</b>  |
| 5.1      | Testing upon acceptance .....  | 7         |
| 5.2      | Packaging / return transport .....                                   | 7         |
| <b>6</b> | <b>Unpacking, Setup and Commissioning</b> .....                      | <b>8</b>  |
| 6.1      | Installation Site, Location of Use .....                             | 8         |
| 6.2      | Unpacking .....  | 8         |
| 6.2.1    | Placing.....   | 8         |
| 6.2.2    | Scope of delivery / serial accessories .....                         | 8         |
| 6.3      | Appliance overview .....   | 9         |
| 6.4      | Controls.....  | 10        |
| 6.4.1    | Overview of display .....  | 10        |
| 6.4.2    | Keyboard overview .....  | 10        |
| 6.5      | Connect and switch-on power supply .....                             | 11        |
| 6.6      | Rechargeable battery operation.....                                  | 11        |
| 6.7      | Connection of peripheral devices.....                                | 12        |
| 6.8      | Initial Commissioning .....  | 12        |
| 6.8.1    | Stability display.....   | 12        |
| 6.8.2    | Balance zero display .....   | 12        |
| <b>7</b> | <b>Adjustment</b> .....  | <b>12</b> |
| 7.1.1    | Adjustment with recommended adjustment weight (factory setting)..... | 13        |
| 7.1.2    | Adjustment with weights of other nominal values .....                | 14        |
| <b>8</b> | <b>Basic Operation</b> .....   | <b>15</b> |
| 8.1      | Underfloor weighing.....   | 16        |

|             |  |           |
|-------------|--|-----------|
| <b>9</b>    | <b>User menu .....</b>   | <b>17</b> |
| <b>9.1</b>  | <b>Weighing unit.....</b>  | <b>20</b> |
| <b>9.2</b>  | <b>Data output type .....</b>  | <b>21</b> |
| <b>9.3</b>  | <b>Baud rate .....</b>   | <b>22</b> |
| <b>9.4</b>  | <b>Auto Zero.....</b>  | <b>23</b> |
| <b>9.5</b>  | <b>Filter .....</b>  | <b>25</b> |
| <b>9.6</b>  | <b>Standstill control display .....</b>                                | <b>26</b> |
| <b>9.7</b>  | <b>Display background illumination .....</b>                           | <b>27</b> |
| <b>9.8</b>  | <b>Automatic switch-off function „AUTO OFF“ in stand-by mode .....</b> | <b>28</b> |
| <b>10</b>   | <b>User menu .....</b>   | <b>29</b> |
| <b>10.1</b> | <b>Parts counting .....</b>  | <b>30</b> |
| 10.1.1      | Switching over between quantity and weight display.....                | 32        |
| 10.1.2      | Automatic reference optimization.....                                  | 32        |
| 10.1.3      | Numeric entering of the reference weight.....                          | 33        |
| <b>10.2</b> | <b>Density determination (Hydrostatic weighing) .....</b>              | <b>34</b> |
| 10.2.1      | Density determination of solids .....                                  | 34        |
| 10.2.2      | Determining density of liquids .....                                   | 36        |
| <b>10.3</b> | <b>Checkweighing .....</b>   | <b>38</b> |
| <b>10.4</b> | <b>Percent determination.....</b>                                      | <b>40</b> |
| 10.4.1      | Entering the reference weight by weighing.....                         | 40        |
| 10.4.2      | Numeric entering of the reference weight.....                          | 41        |
| <b>10.5</b> | <b>Peak value function.....</b>  | <b>42</b> |
| <b>11</b>   | <b>Data output RS 232C .....</b>                                       | <b>43</b> |
| <b>11.1</b> | <b>Technical Data .....</b>  | <b>43</b> |
| <b>11.2</b> | <b>Pin allocation of balance output plug.....</b>                      | <b>43</b> |
| <b>11.3</b> | <b>Interface.....</b>  | <b>44</b> |
| <b>11.4</b> | <b>Data transfer .....</b>   | <b>44</b> |
| <b>11.5</b> | <b>Format for data transmission.....</b>                               | <b>45</b> |
| <b>11.6</b> | <b>Remote control instructions.....</b>                                | <b>46</b> |
| <b>11.7</b> | <b>Printer mode .....</b>  | <b>46</b> |
| <b>12</b>   | <b>Error messages.....</b>   | <b>48</b> |
| <b>13</b>   | <b>Service, maintenance, disposal.....</b>                             | <b>48</b> |
| <b>13.1</b> | <b>Cleaning .....</b>  | <b>48</b> |
| <b>13.2</b> | <b>Service, maintenance.....</b>                                       | <b>48</b> |
| <b>13.3</b> | <b>Disposal.....</b>   | <b>48</b> |
| <b>14</b>   | <b>Instant help.....</b>   | <b>49</b> |

# 1 Technical Data

| KERN   | PLE 420-3N                         | PLE 4200-2N |
|--|------------------------------------|-------------|
| Weighing range (max)                             | 420 g                              | 4200 g      |
| Readability (d)                                  | 0.001 g                            | 0.01 g      |
| Reproducibility                                  | 0.002 g                            | 0.02 g      |
| Linearity  | ± 0.003 g                          | ± 0.03 g    |
| Stabilization time (typical)                     | 2 sec                              | 2 sec       |
| Minimum unit weight at piece counting            | 0.005 g                            | 0.005 g     |
| Warm-up time                                     | 4 hours                            |             |
| Recommended adjustment weight, not added (class) | 400 g (E2)                         | 4000 g (E2) |
| Reference quantities at piece counting           | 10, 25, 50, 100                    |             |
| Weighing Units                                   | ct, dwt, g, gn, mg, mo, oz, ozt, t |             |
| Electric Supply                                  | 220V-240V, AC 50Hz                 |             |
| Operating temperature                            | + 10° C .... + 30° C               |             |
| Humidity of air                                  | max. 80 % (not condensing)         |             |
| Underfloor weighing                              | Clevis type eyelet                 |             |
| Housing (B x D x H) mm                           | 185 x 250 x 80                     |             |
| Dimensions of windshield (B x D x H) mm          | 150 (inside)<br>160 (outside)      |             |
| Weighing plate (stainless steel)                 | Ø 80                               | Ø 135       |
| Weight kg (net)                                  | 1,5 kg                             |             |
| Interface  | RS 232C                            |             |

## 2 Declaration of conformity



**KERN & Sohn GmbH**

D-72322 Balingen-Frommern

Postbox 4052

email: info@kern-sohn.de

Phone: 0049-[0]7433- 9933-0

Fax: 0049-[0]7433-9933-149

Internet: www.kern-sohn.de

### Declaration of conformity

**EC-Konformitätserklärung**  
**EC- Déclaration de conformité**  
**EC-Dichiarazione di conformità**  
**EC- Declaração de conformidade**  
**EC-Deklaracja zgodności**

**EC-Declaration of -Conformity**  
**EC-Declaración de Conformidad**  
**EC-Conformiteitverklaring**  
**EC- Prohlášení o shode**  
**EC-Заявление о соответствии**

|            |                                |  |
|------------|--------------------------------|--|
| <b>D</b>   | Konformitäts-<br>erklärung     | Wir erklären hiermit, dass das Produkt, auf das sich diese Erklärung bezieht, mit den nachstehenden Normen übereinstimmt.                    |
| <b>GB</b>  | Declaration of<br>conformity   | We hereby declare that the product to which this declaration refers conforms to the following standards.                                     |
| <b>CZ</b>  | Prohlášení o<br>shode          | Tímto prohlašujeme, že výrobek, kterého se toto prohlášení týká, je v souladu s níže uvedenými normami.                                      |
| <b>E</b>   | Declaración de<br>conformidad  | Manifetamos en la presente que el producto al que se refiere esta declaración está de acuerdo con las normas siguientes                      |
| <b>F</b>   | Déclaration de<br>conformité   | Nous déclarons avec cela responsabilité que le produit, auquel se rapporte la présente déclaration, est conforme aux normes citées ci-après. |
| <b>I</b>   | Dichiarazione di<br>conformità | Dichiariamo con ciò che il prodotto al quale la presente dichiarazione si riferisce è conforme alle norme di seguito citate.                 |
| <b>NL</b>  | Conformiteit-<br>verklaring    | Wij verklaren hiermede dat het product, waarop deze verklaring betrekking heeft, met de hierna vermelde normen overeenstemt.                 |
| <b>P</b>   | Declaração de<br>conformidade  | Declaramos por meio da presente que o produto no qual se refere esta declaração, corresponde às normas seguintes.                            |
| <b>PL</b>  | Deklaracja<br>zgodności        | Niniejszym oświadczamy, że produkt, którego niniejsze oświadczenie dotyczy, jest zgodny z poniższymi normami.                                |
| <b>RUS</b> | Заявление о<br>соответствии    | Мы заявляем, что продукт, к которому относится данная декларация, соответствует перечисленным ниже нормам.                                   |

### Electronic Balance: PLE-N

| Mark applied | EU Directive | Standards   |
|--------------|--------------|---|
| <b>CE</b>    | 2004/108/EC  | EN 61326-1 (2006)<br>EN 61000-3-2 (2006)<br>EN 61000-3-3 (1995) + A1 (2001) + A2 (2005) |
|              | 2006/95/EC   | EN 61010-1 (2001)   |

Date: 27.12.2008

Signature:

Gottl. KERN & Sohn GmbH  
 Management

Gottl. KERN & Sohn GmbH, Ziegelei 1, D-72336 Balingen, Tel. +49-[0]7433/9933-0, Fax +49-[0]7433/9933-149

## 3 Basic Information (General)

### 3.1 Proper use

The balance you purchased is intended to determine the weighing value of material to be weighed. It is intended to be used as a “non-automatic” balance, i.e. the material to be weighed is manually and carefully placed in the centre of the weighing plate. As soon as a stable weighing value is reached the weighing value can be read.

### 3.2 Improper Use

Do not use balance for dynamic weighing. In the event that small quantities are removed or added to the material to be weighed, incorrect weighing results can be displayed due to the “stability compensation” in the balance. (Example: Slowly draining fluids from a container on the balance.)

Do not leave permanent load on the weighing plate. This may damage the measuring system.

Impacts and overloading exceeding the stated maximum load (max) of the balance, minus a possibly existing tare load, must be strictly avoided. Balance may be damaged by this.

Never operate balance in explosive environment. The serial version is not explosion protected.

The structure of the balance may not be modified. This may lead to incorrect weighing results, safety-related faults and destruction of the balance.

The balance may only be used according to the described conditions. Other areas of use must be released by KERN in writing.

### 3.3 Warranty

Warranty claims shall be voided in case

- Our conditions in the operation manual are ignored
- The appliance is used outside the described uses
- The appliance is modified or opened
- Mechanical damage or damage by media, liquids, natural wear and tear
- The appliance is improperly set up or incorrectly electrically connected
- The measuring system is overloaded

### 3.4 Monitoring of Test Resources

In the framework of quality assurance the measuring-related properties of the balance and, if applicable, the testing weight, must be checked regularly. The responsible user must define a suitable interval as well as type and scope of this test. Information is available on KERN's home page ([www.kern-sohn.com](http://www.kern-sohn.com)) with regard to the monitoring of balance test substances and the test weights required for this. In KERN's accredited DKD calibration laboratory test weights and balances may be calibrated (return to the national standard) fast and at moderate cost.

## 4 Basic Safety Precautions

### 4.1 Pay attention to the instructions in the Operation Manual



Carefully read this operation manual before setup and commissioning, even if you are already familiar with KERN balances.

### 4.2 Personnel training

The appliance may only be operated and maintained by trained personnel.

## 5 Transportation & Storage

### 5.1 Testing upon acceptance

When receiving the appliance, please check packaging immediately, and the appliance itself when unpacking for possible visible damage.

### 5.2 Packaging / return transport



- ⇒ Keep all parts of the original packaging for a possibly required return.
- ⇒ Only use original packaging for returning.
- ⇒ Prior to dispatch disconnect all cables and remove loose/mobile parts.
- ⇒ Reattach possibly supplied transport securing devices.
- ⇒ Secure all parts such as the glass wind screen, the weighing platform, power unit etc. against shifting and damage.

## 6 Unpacking, Setup and Commissioning

### 6.1 Installation Site, Location of Use

The balances are designed in a way that reliable weighing results are achieved in common conditions of use.

You will work accurately and fast, if you select the right location for your balance.

**Therefore, observe the following for the installation site:**

- Place the balance on a firm, level surface;
- Avoid extreme heat as well as temperature fluctuation caused by installing next to a radiator or in the direct sunlight;
- Protect the balance against direct draughts due to open windows and doors;
- Avoid jarring during weighing;
- Protect the balance against high humidity, vapors and dust;
- Do not expose the device to extreme dampness for longer periods of time. Non-permitted condensation (condensation of air humidity on the appliance) may occur if a cold appliance is taken to a considerably warmer environment. In this case, acclimatize the disconnected appliance for ca. 2 hours at room temperature.
- Avoid static charge of goods to be weighed or weighing container.

Major display deviations (incorrect weighing results) may be experienced should electromagnetic fields (e.g. due to mobile phones or radio equipment), static electricity accumulations or instable power supply occur. Change location or remove source of interference.

### 6.2 Unpacking

Carefully remove the balance from the packaging, remove plastic cover and setup balance at the intended workstation.

#### 6.2.1 Placing

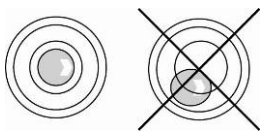

Level balance with foot screws until the air bubble of the water balance is in the prescribed circle.

#### 6.2.2 Scope of delivery / serial accessories

- Balance, Weighing plate
- Mains power supply
- Windshield
- Operating Manual

### 6.3 Appliance overview

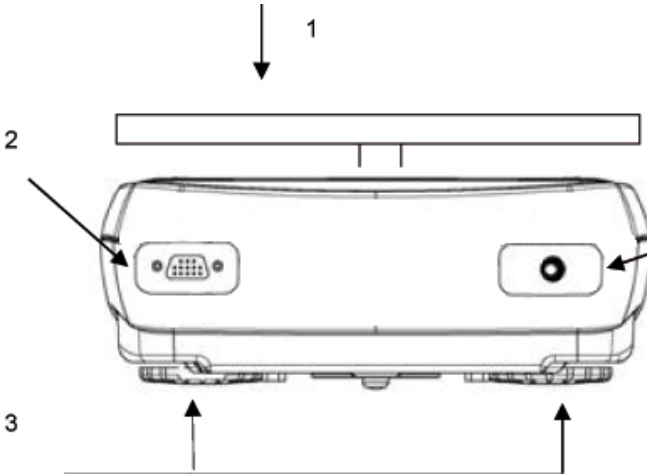

- 1. Weighing plate
- 2. RS232C interface
- 3. Foot screws
- 4. Mains adapter connection

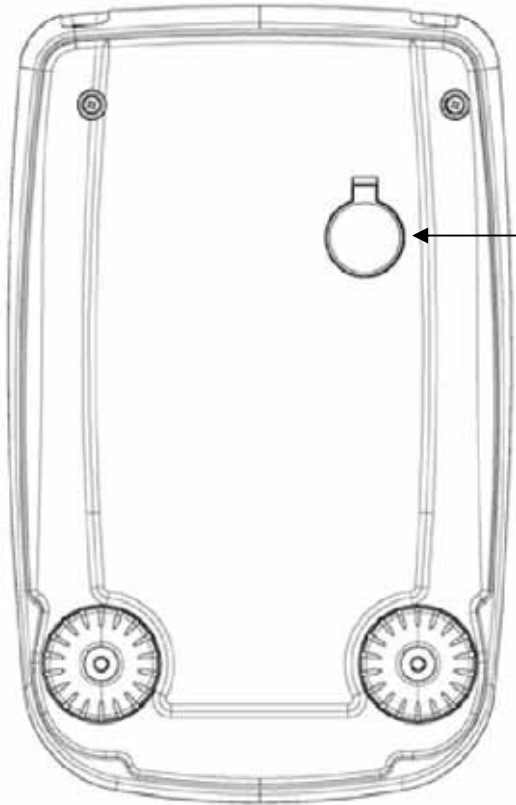



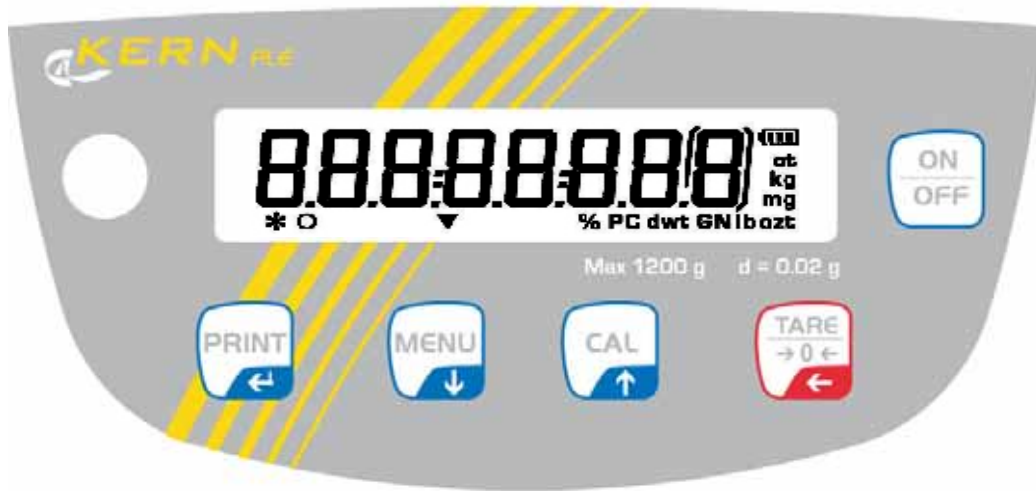

- 5. Underfloor weighing device

## 6.4 Controls

### 6.4.1 Overview of display



### 6.4.2 Keyboard overview

| Key   | Designation          | Short key pressing  | longtime pressed button until the acoustic signal gets mute  |
|---|----------------------|---|--|
|  | <b>MENU</b> button/  | <ul style="list-style-type: none"> <li>Call-up application menu</li> <li>Select menu items – scroll forward</li> </ul>    | <ul style="list-style-type: none"> <li>Call-up user menu</li> <li>Exit user menu</li> <li>Switch-over display</li> </ul> |
|   | Arrow button ↓       | <ul style="list-style-type: none"> <li>numerical input – scroll backward</li> </ul>                                       |  |
|  | <b>ON/OFF</b> switch | <ul style="list-style-type: none"> <li>Turn on/off</li> <li>Exit user menu</li> </ul>                                     |  |
|  | <b>CAL</b> button/   | <ul style="list-style-type: none"> <li>Adjustment</li> <li>Select menu items – scroll backward</li> </ul>                 |  |
|   | Arrow button ↑       | <ul style="list-style-type: none"> <li>Numerical input – scroll forward</li> </ul>  |  |
|  | <b>PRINT</b> button  | <ul style="list-style-type: none"> <li>Calculate weighing data via interface</li> <li>Confirm / store settings</li> </ul> |  |
|   | Arrow button ←       | <ul style="list-style-type: none"> <li>Numerical input – cipher selection</li> </ul>                                      |  |
|  | <b>TARE</b> button   | <ul style="list-style-type: none"> <li>Taring</li> <li>Zeroing</li> </ul>   |  |

## 6.5 Connect and switch-on power supply

Before connecting the mains adapter check if the printed voltage value is the same as the local supply voltage. Only use KERN original mains adapter. Using other makes requires consent by KERN.

- ⇒ Plug-in mains adapter in mains adapter bushing of the balance and connect to the mains.
- ⇒ The balance will carry out a self-test Then the balance is set into stand-by mode.



- ⇒ Press the **ON/OFF** key. When the zero display appears, the balance is ready for operation. When weighing with internal adjustment weight, adjustment first occurs automatically. During this process, „CAL“ will appear on the display.
- ⇒ Press the **ON/OFF** key anew. The balance is now in stand-by mode



For verified balances a warming-up time of 30 minutes must be observed.  
After connecting the mains adapter a countdown starts.

## 6.6 Rechargeable battery operation



**The rechargeable battery is charged via the delivered power supply.**

The operating time of the rechargeable battery is about 30h; charging time until complete recharging ca. 10h.

In the menu you can activate the AUTO-OFF function [time off], see chp. 9.8.

According to menu settings, the balance switches automatically off in order to spare the battery.

When the balance is in battery mode the following symbols appear on the display:

|   |   |
|---|---|
|  | Battery charge sufficient   |
|  | Battery very low. Connect mains adapter as soon as possible to load the rechargeable battery.         |
|  | Voltage has dropped below prescribed minimum. Connect mains adapter to load the rechargeable battery. |

## 6.7 Connection of peripheral devices

Before connecting or disconnecting of additional devices (printer, PC) to the data interface, always disconnect the balance from the power supply.

With your balance, only use accessories and peripheral devices by KERN, as they are ideally tuned to your balance.

## 6.8 Initial Commissioning

In order to obtain exact results with the electronic balances, your balance must have reached the operating temperature (see warming up time chap. 1).

During this warming up time the balance must be connected to the power supply (mains, accumulator or battery).

The accuracy of the balance depends on the local acceleration of gravity.

Strictly observe hints in chapter Adjustment.

### 6.8.1 Stability display

If the display shows the stability display [**\***] the balance is in a stable status. If the status is instable the [**\***] display disappears.

### 6.8.2 Balance zero display

If an exact zero reading is not displayed on the balance in spite of the weighing dish being empty, press the **TARE** button and the balance will start resetting to zero [**0**].

## 7 Adjustment

As the acceleration value due to gravity is not the same at every location on earth, each balance must be coordinated - in compliance with the underlying physical weighing principle - to the existing acceleration due to gravity at its place of location (only if the balance has not already been adjusted to the location in the factory). This adjustment process must be carried out for the first commissioning, after each change of location as well as in case of fluctuating environment temperature. To receive accurate measuring values it is also recommended to adjust the balance periodically in weighing operation.

- ⇒ Observe stable environmental conditions. A warming up time (see chapter 1) is required for stabilization.
- ⇒ Ensure that there are no objects on the weighing plate.

### 7.1.1 Adjustment with recommended adjustment weight (factory setting)

Weight value of the required adjustment weight see chpt. 1 "Technical specifications":



⇒ Ensure that there are no objects on the weighing plate. Press the **CAL** key



⇒ Wait until the weighed value for the required adjustment weight appears flashing.



⇒ **During** the flashing display put the required adjustment weight carefully in the center of the weighing plate.  
The flashing display disappears.  
After successful adjustment the balance automatically returns to weighing mode.

⇒ Take away adjustment weight



## 7.1.2 Adjustment with weights of other nominal values

Weights of different nominal values may be used for adjustment but are not optimal for technical measuring, possible adjustment points see table 1.

Info about adjustment weights can be found on the Internet at: <http://www.kern-sohn.com>



- ⇒ Ensure that there are no objects on the weighing plate. Press the **CAL** button and keep it pressed until the acoustic signal gets mute.



- ⇒ Wait until „load“ appears.



- ⇒ **During** the flashing display put the adjustment weight carefully in the center of the weighing plate.  
The flashing display disappears.  
After successful adjustment the balance automatically returns to weighing mode.
- ⇒ Take away adjustment weight



- i** An error message will be displayed in the event of an adjustment error or incorrect adjustment weight. Wait until the balance is again in weighing mode and repeat the adjustment procedure.

## 8 Basic Operation

### Start-up

In stand-by mode press ON/OFF button.  
The balance is ready for weighing when the weight display appears.

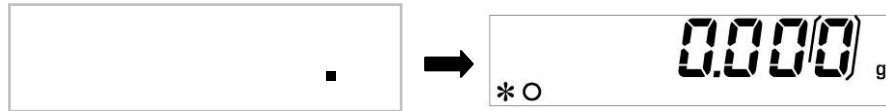

### Switching Off

Press ON/OFF button, the balance returns to the stand-by mode.

### Simple weighing

- ⇒ Place goods to be weighed on balance
- ⇒ Wait until the stability display appears [\*]



- ⇒ Read weighing result.

### Taring

- ⇒ Place the weighing box and press the **TARE** button. „0-t“ is displayed.

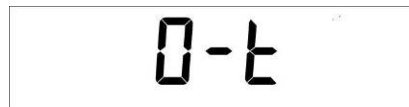

- ⇒ After standstill control the zero display appears.



The weight of the container is now internally saved.

- ⇒ Weigh the material, the net weight will be indicated.

The weight of the weighing container will be displayed as a minus number after removing the weighing container.

The tare weight is saved until it is deleted. Remove the load from the balance and press the **TARE** button. „0-t“ is displayed, wait until the zero display appears.

The tare procedure can be repeated as many times as necessary, for example with initial weighing of several components for a mix (add-on weighing). The limit is reached when the total weighing range capacity is full.

## 8.1 Underfloor weighing

Objects unsuitable for placing on the weighing scale due to size or shape may be weighed with the help of the flush-mounted platform.

Proceed as follows:

- Switch off the balance
- Open closing cover (1) at the balance bottom.
- Suspend hook for underfloor weighing **carefully and completely**.
- Place weighing balance over an opening.
- Attach load to hook and carry out weighing procedure.

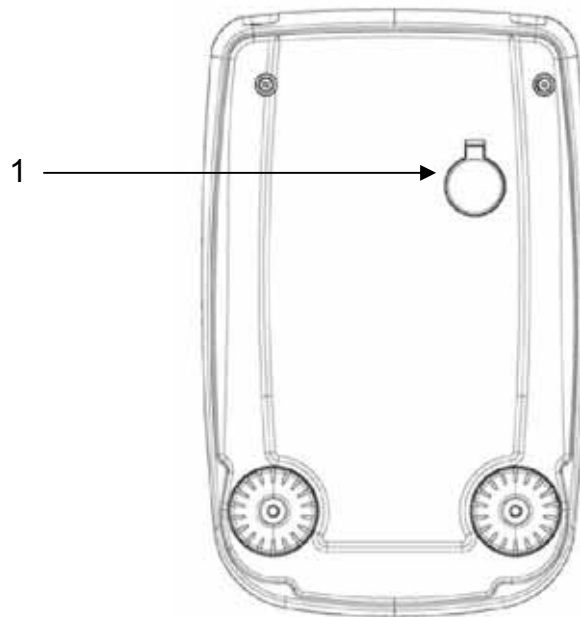

Fig. 1: Setup of balance for underfloor weighing



- Always ensure that all suspended objects are stable enough to hold the desired goods to be weighed safely (danger of breaking).
- Never suspend loads that exceed the stated maximum load (max) (danger of breaking)
- Always ensure that there are no persons, animals or objects that might be damaged underneath the load.



After completing the underfloor weighing the opening on the bottom of the balance must always be closed (dust protection).

## 9 User menu

The settings of the balance can be changed in the user menu. This way, the balance can be adjusted to individual weighing requirements.

By the factory the user menu has been set in a way that normally no more changes must be made, only at special conditions of use.

### Navigation in the menu

|   |   |
|---|---|
| <b>Access to menu</b>                           | In weighing mode press the <b>MENU</b> button and keep it pressed until the acoustic signal gets mute. The first menu item „units“ is displayed.  |
| <b>How to select menu items</b>                 | Using the <b>MENU</b> button the individual menu items can be selected one after the other.<br><br>⇒ Scroll forward using <b>MENU</b> button<br>⇒ Scroll backward using <b>CAL</b> button   |
| <b>Change settings</b>                          | Acknowledge selected menu item using <b>PRINT</b> button, the current setting is displayed. Each time the arrow buttons ↓ ↑ are pressed the next setting will be displayed.<br><br>⇒ Scroll forward using <b>MENU</b> button<br>⇒ Scroll backward using <b>CAL</b> button |
| <b>Save settings</b>                            | Take over selection using the <b>PRINT</b> button. Weighing balance returns to menu. Either make more settings in the menu or go back to menu mode as follows.  |
| <b>Exit menu/<br/>back to<br/>weighing mode</b> | Press the <b>MENU</b> button and keep it pressed until the acoustic signal gets mute. The balance returns automatically into weighing mode.   |

## Menu overview

| Menu item                                     | Display        | Selection       | Description  |
|---|----------------|-----------------|--|
| Weighing unit<br>(see chap. 9.1)              | <b>Units</b>   | <b>Gram</b>     | Gramm  |
|   |                | <b>Carat</b>    | Carat  |
|   |                | <b>Ounce</b>    | Unze   |
|   |                | <b>Pound</b>    | Pound  |
|   |                | <b>PEnn</b>     | Pennyweight  |
|   |                | <b>OuncEtr</b>  | Troy Unze  |
|   |                | <b>GrAin</b>    | Grain  |
|   |                | <b>tAEL Hon</b> | Tael Hongkong  |
|   |                | <b>tAEL SGP</b> | Tael Singapore   |
|   |                | <b>tAEL roc</b> | Tael R.O.C.  |
|   |                | <b>Momme</b>    | Momme  |
| Data output type<br>(see chap. 9.2)           | <b>PC-Prtr</b> | <b>PC cont</b>  | Continuous output  |
|   |                | <b>PC CMd</b>   | Manual issue after pressing the <b>PRINT</b> button        |
|   |                | <b>Print</b>    | not documented   |
| Baudrate<br>(see chap. 9.3)                   | <b>baud rt</b> | <b>br 1200</b>  |  |
|   |                | <b>br 2400</b>  |  |
|   |                | <b>br 4800</b>  |  |
|   |                | <b>br 9600</b>  |  |
| Aukto zero<br>(see chap. 9.4)                 | <b>Auto 0</b>  | <b>Au0 OFF</b>  | Auto Zero switched off                                     |
|   |                | <b>Au0 1</b>    | Auto Zero range $\pm \frac{1}{2}$ digit                    |
|   |                | <b>Au0 2</b>    | Auto Zero range $\pm 3$ digits                             |
|   |                | <b>Au0 3</b>    | Auto Zero range $\pm 7$ digits                             |
|   |                | <b>Au0 3E</b>   | Auto Zero range $\pm 7$ digits in the whole weighing range |
| Filter<br>(see chap. 9.5)                     | <b>Filter</b>  | <b>Filt 1</b>   | Setting for dispensing                                     |
|   |                | <b>Filt 2</b>   | Sensitive and fast, very quiet set-up location             |
|   |                | <b>Filt 3</b>   | Robust but slow, busy set-up locatio                       |
| Standstill control display<br>(see chap. 9.6) | <b>Stabil</b>  | <b>Stab 1</b>   | Standstill control fast – very quiet set-up location       |
|   |                | <b>Stab 2</b>   | Standstill control fast + exact – quiet set-up location    |
|   |                | <b>Stab 3</b>   | Standstill control exact – very set-up location            |

|   |                 |               |  |
|---|-----------------|---------------|--|
| Backlight (see chap. 9.7)                       | <b>Blt</b>      | <b>on</b>     | Backlight on   |
|   |                 | <b>off</b>    | Backlight off  |
|   |                 | <b>Auto</b>   | Backlight automatically switched off 3 seconds after achieving stable weighing value. Changes in weight or pressing of keys will automatically result in backlight switching on again. |
| AUTO OFF<br>in stand-by mode<br>(see chap. 9.8) | <b>time off</b> | <b>disab</b>  | AUTO-OFF off   |
|   |                 | <b>2 Min</b>  | AUTO-OFF after 2 minutes without changing the weight   |
|   |                 | <b>5 Min</b>  | AUTO-OFF after 5 minutes without changing the weight   |
|   |                 | <b>15 Min</b> | AUTO-OFF after 15 minutes without changing the weight  |
| Adjustment<br>(see chap. 7)                     | <b>Calib</b>    | <b>E-Cal</b>  | Adjustment with external weight, locked for verifiable units   |
|   | <b>End</b>      |               |  |

## 9.1 Weighing unit

According to requirements the balance can be switched-over into different units (in verified balances not all the units are available, see chap. 1 „Technical specifications“). Selected weighing unit will be retained even after disconnection from the mains.

- ⇒ In weighing mode press the **MENU** button and keep it pressed until the acoustic signal gets mute. The first menu item „units“ is displayed.

Units

- ⇒ Acknowledge using **PRINT** button, the current setting is displayed.

G-AN

- ⇒ Press the arrow keys **↓** **↑** to select desired setting.

Scroll forward using **MENU** button

Scroll backward using **CAL** button

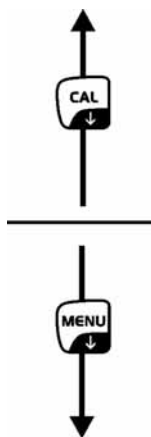

| Symbol   | Weighing unit  | Conversion factor 1g = |
|----------|----------------|------------------------|
| Gram     | GRAMS          | 1.                     |
| Carat    | CARATS         | 5.                     |
| Ounce    | OUNCE          | 0.035273962            |
| Pound    | POUNDS         | 0.0022046226           |
| PEnn     | PENNYWEIGHTS   | 0.643014931            |
| OuncEtr  | OUNCE TROY     | 0.032150747            |
| GrAin    | GRAIN          | 15.43235835            |
| tAEL Hon | HONG KONG Tael | 0.02671725             |
| tAEL SGP | SYNGAPORE Tael | 0.02646063             |
| tAEL roc | R.O.C. Tael    | 0.02666666             |
| Momme    | MOMME          | 0.2667                 |

- ⇒ Take over selection using the **PRINT** button. Weighing balance returns to menu. Either make more settings in the menu or go back to weighing mode as follows.
- ⇒ Press the **MENU** button and keep it pressed until the acoustic signal gets mute. The balance returns automatically into weighing mode.

## 9.2 Data output type

⇒ In weighing mode press the **MENU** button and keep it pressed until the acoustic signal gets mute.



Unit5

⇒ Press **MENU** button

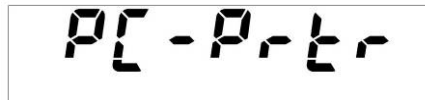

Pr-Prtr

⇒ Acknowledge using **PRINT** button, the current setting is displayed.

⇒ Press the arrow keys **↓** **↑** to select desired setting.

Scroll forward using **MENU** button

Scroll backward using **CAL** button



PC Cont



Pr Cmd



Pr int

„PC cont“ = Continuous output

„PC Cmd“ = Manual issue after pressing the **PRINT** button

„Print“ = not documented

⇒ Take over selection using the **PRINT** button.  
Weighing balance returns to menu. Either make more settings in the menu or go back to weighing mode as follows.

⇒ Press the **MENU** button and keep it pressed until the acoustic signal gets mute.  
The balance returns automatically into weighing mode.



\* 0 0.0000 g

### 9.3 Baud rate

- ⇒ In weighing mode press the **MENU** button and keep it pressed until the acoustic signal gets mute.

A rectangular box containing the text "Units" in a digital font.

- ⇒ Press **MENU** button repeatedly

A rectangular box containing the text "bAud rt" in a digital font.

- ⇒ Acknowledge using **PRINT** button, the current setting is displayed.
- ⇒ Press the arrow keys **↓** **↑** to select desired setting.

Scroll forward using **MENU** button

Scroll backward using **CAL** button

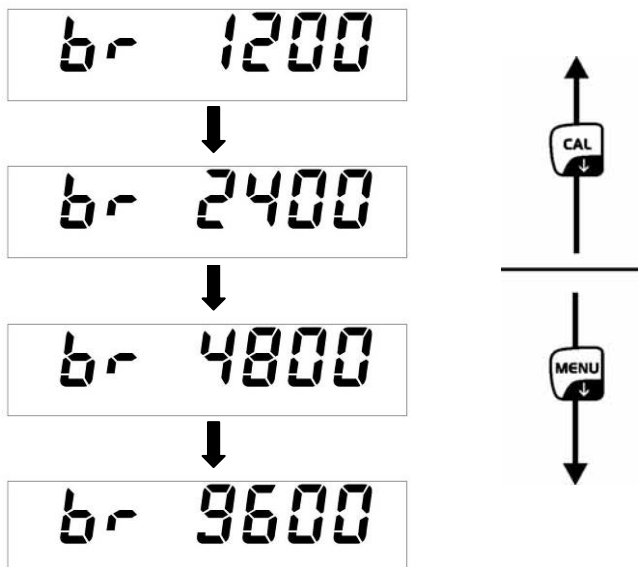

- ⇒ Take over selection using the **PRINT** button. Weighing balance returns to menu. Either make more settings in the menu or go back to weighing mode as follows.
- ⇒ Press the **MENU** button and keep it pressed until the acoustic signal gets mute. The balance returns automatically into weighing mode.

A rectangular box containing the text "0.0000 g" in a large digital font, with "\* O" in a smaller font to the left.

## 9.4 Auto Zero

Under this menu item the automatic zero point correction can be switched on or off. In switched-on-state the zero point is automatically corrected at drift or when dirty.

Information:

In the event that small quantities are removed or added to the material to be weighed, incorrect weighing results can be displayed due to the “stability compensation” in the balance. (e.g. slow flow of liquids from a container placed on the balance, evaporating processes).

When apportioning involves small variations of weight, it is advisable to switch off this function.

- ⇒ In weighing mode press the **MENU** button and keep it pressed until the acoustic signal gets mute.

A rectangular digital display showing the word "Units" in a black, seven-segment font.

- ⇒ Press **MENU** button repeatedly

A rectangular digital display showing the text "Auto 0" in a black, seven-segment font.

- ⇒ Acknowledge using **PRINT** button, the current setting is displayed.

⇒ Press the arrow keys **↓** **↑** to select desired setting.

Scroll forward using **MENU** button

Scroll backward using **CAL** button

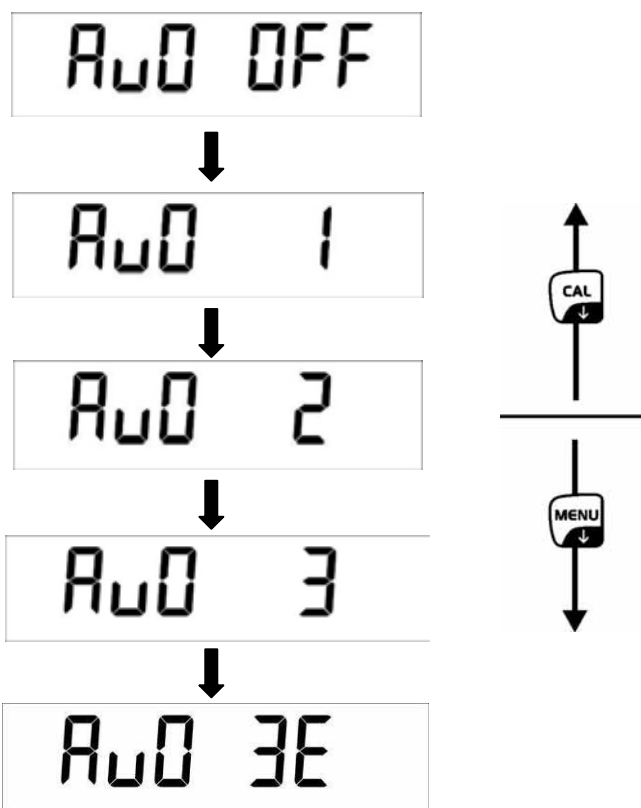

- Au0 OFF** = Auto Zero switched off
- Au0 1** = Auto Zero range  $\pm \frac{1}{2}$  digit
- Au0 2** = Auto Zero range  $\pm 3$  digits
- Au0 3** = Auto Zero range  $\pm 7$  digits
- Au0 3E** = Auto Zero range  $\pm 7$  digits in the whole weighing range

⇒ Take over selection using the **PRINT** button.  
Weighing balance returns to menu. Either make more settings in the menu or go back to weighing mode as follows.

⇒ Press the **MENU** button and keep it pressed until the acoustic signal gets mute.  
The balance returns automatically into weighing mode.



## 9.5 Filter

This menu item allows the balance to be set according to specific ambient conditions and measuring purposes.

- ⇒ In weighing mode press the **MENU** button and keep it pressed until the acoustic signal gets mute.

A rectangular box containing the text "Units" in a digital font.

- ⇒ Press **MENU** button repeatedly

A rectangular box containing the text "Filter" in a digital font.

- ⇒ Acknowledge using **PRINT** button, the current setting is displayed.
- ⇒ Press the arrow keys **↓** **↑** to select desired setting.

Scroll forward using **MENU** button

Scroll backward using **CAL** button

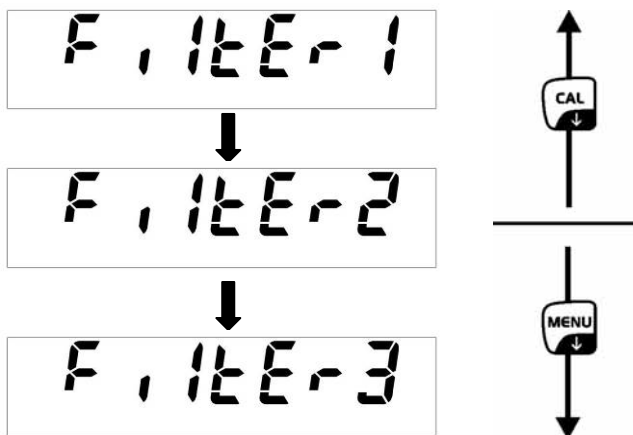

**FILTER 1:** Setting for dispensing

**FILTER 2:** Sensitive and fast, very quiet set-up location.

**FILTER 3:** Robust but slow, busy set-up location.

- ⇒ Take over selection using the **PRINT** button.  
Weighing balance returns to menu. Either make more settings in the menu or go back to weighing mode as follows.
- ⇒ Press the **MENU** button and keep it pressed until the acoustic signal gets mute.  
The balance returns automatically into weighing mode.

A rectangular box containing the text "\* O" on the left and "0.0000 g" on the right in a digital font.

## 9.6 Standstill control display

- ⇒ In weighing mode press the **MENU** button and keep it pressed until the acoustic signal gets mute.

A rectangular digital display showing the word "Units" in a large, black, seven-segment font.

- ⇒ Press **MENU** button repeatedly

A rectangular digital display showing "STAB IL" in a large, black, seven-segment font.

- ⇒ Acknowledge using **PRINT** button, the current setting is displayed.
- ⇒ Press the arrow keys **↓** **↑** to select desired setting.

Scroll forward using **MENU** button

Scroll backward using **CAL** button

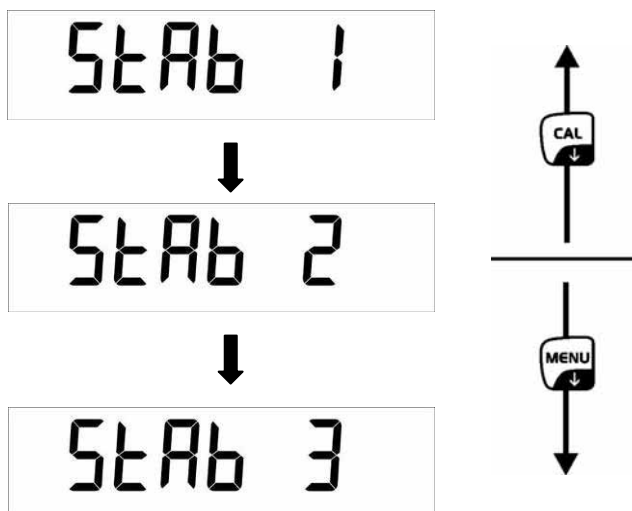

**STAB 1:** Standstill control fast – very quiet set-up location

**STAB 2:** Standstill control fast + exact – quiet set-up location

**STAB 3:** Standstill control exact – very set-up location.

- ⇒ Take over selection using the **PRINT** button.  
Weighing balance returns to menu. Either make more settings in the menu or go back to weighing mode as follows.
- ⇒ Press the **MENU** button and keep it pressed until the acoustic signal gets mute.  
The balance returns automatically into weighing mode.

A rectangular digital display showing "0.000" in a large, black, seven-segment font, with a small "g" to its right. Below the display, on the left side, is a small "\* O" symbol.

## 9.7 Display background illumination

- ⇒ In weighing mode press the **MENU** button and keep it pressed until the acoustic signal gets mute.

A rectangular digital display showing the word "Units" in a seven-segment font.

- ⇒ Press **MENU** button repeatedly

A rectangular digital display showing "bLk" in a seven-segment font.

- ⇒ Acknowledge using **PRINT** button, the current setting is displayed.
- ⇒ Press the arrow keys **↓** **↑** to select desired setting.

Scroll forward using **MENU** button

Scroll backward using **CAL** button

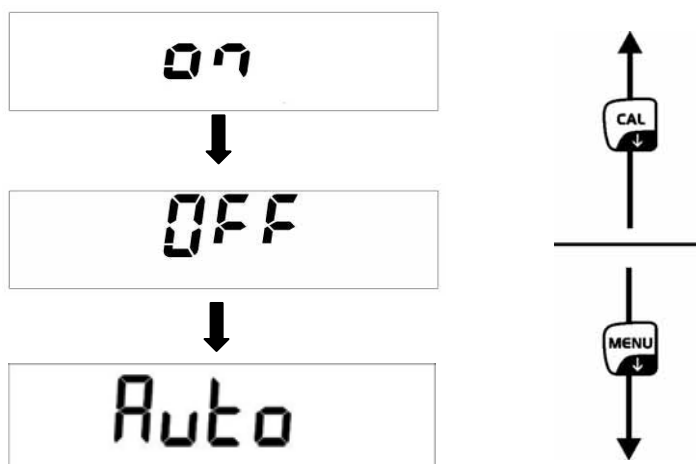

**ON** Background illumination on

**OFF** Background illumination off

**Auto** Backlighting automatically switched off 3 seconds after achieving stable weighing value. Changes in weight or pressing of keys will automatically result in backlight switching on again.

- ⇒ Take over selection using the **PRINT** button. Weighing balance returns to menu. Either make more settings in the menu or go back to weighing mode as follows.

- ⇒ Press the **MENU** button and keep it pressed until the acoustic signal gets mute. The balance returns automatically into weighing mode.

A rectangular digital display showing "0.0000" in a seven-segment font, followed by a small "g" unit symbol. In the bottom left corner, there is a "\* O" indicator.

## 9.8 Automatic switch-off function „AUTO OFF“ in stand-by mode

⇒ In weighing mode press the **MENU** button and keep it pressed until the acoustic signal gets mute.

Unit5

⇒ Press **MENU** button repeatedly

Time off

⇒ Acknowledge using **PRINT** button, the current setting is displayed.

⇒ Press the arrow keys **↓** **↑** to select desired setting.

Scroll forward using **MENU** button

Scroll backward using **CAL** button

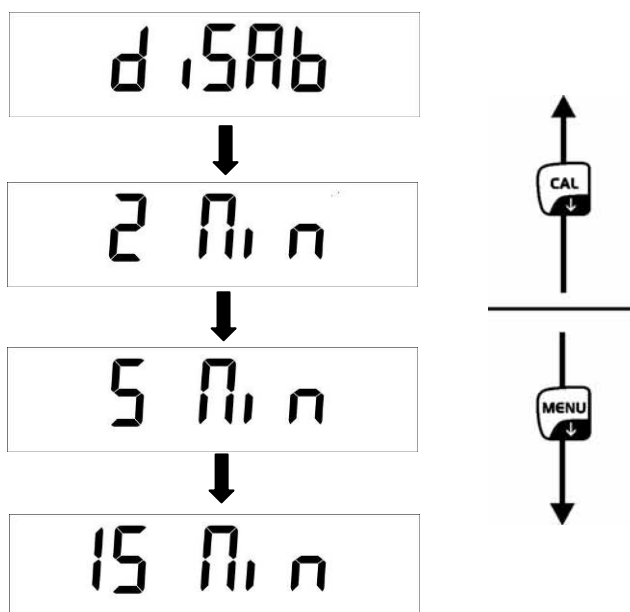

**disab** = AUTO-OFF switched off

**2 Min** = AUTO-OFF after 2 minutes without changing the weight

**5 Min** = AUTO-OFF after 5 minutes without changing the weight

**15 Min** = AUTO-OFF after 15 minutes without changing the weight

⇒ Take over selection using the **PRINT** button.

Weighing balance returns to menu. Either make more settings in the menu or go back to weighing mode as follows.

⇒ Press the **MENU** button and keep it pressed until the acoustic signal gets mute. The balance returns automatically into weighing mode.

\* 0 0.0000 g

## 10 User menu

The following operating modes may be enabled/disabled in the user menu:

|               |   |
|---------------|---|
| <b>Count</b>  | Parts counting                          |
| ↓             |   |
| <b>Dens</b>   | Density determination of solids/liquids |
| ↓             |   |
| <b>HoL</b>    | Checkweighing                           |
| ↓             |   |
| <b>Perc</b>   | Percent determination                   |
| ↓             |   |
| <b>M Load</b> | Peak value function                     |
| ↓             |   |
| <b>End</b>    |   |

### Navigation in the menu

|   |   |
|---|---|
| <b>Access to menu</b>                           | In weighing mode press <b>MENU</b> button. The first menu item „count“ is displayed.  |
| <b>How to select menu items</b>                 | Using the <b>MENU</b> button the individual menu items can be selected one after the other.<br><br>⇒ Scroll forward using <b>MENU</b> button<br>⇒ Scroll backward using <b>CAL</b> button   |
| <b>Change settings</b>                          | Acknowledge selected menu item using <b>PRINT</b> button, the current setting is displayed. Each time the arrow buttons ↓ ↑ are pressed the next setting will be displayed.<br><br>⇒ Scroll forward using <b>MENU</b> button<br>⇒ Scroll backward using <b>CAL</b> button |
| <b>Save settings</b>                            | Take over selection using the <b>PRINT</b> button. Weighing balance returns to menu. Either make more settings in the menu or go back to menu mode as follows.  |
| <b>Exit menu/<br/>back to<br/>weighing mode</b> | Press the <b>MENU</b> button and keep it pressed until the acoustic signal gets mute. The balance returns automatically into weighing mode.   |

## 10.1 Parts counting

Before the balance can count parts, it must know the average part weight (i.e. reference). Proceed by putting on a certain number of the parts to be counted. The balance determines the total weight and divides it by the number of parts, the so-called reference quantity. Counting is then carried out on the basis of the calculated average piece weight.

As a rule:

**The higher the reference quantity the higher the counting exactness.**

⇒ In weighing mode press **MENU** button. The first menu item „count“ is displayed.



⇒ Acknowledge using **PRINT** button, the current reference quantity is displayed.



⇒ Using the arrow buttons **↓** **↑** select reference quantity (10, 25, 50, 100 or manual = numerical input of the reference weight, see chap. 10.1.3).

Scroll forward using **MENU** button

Scroll backward using **CAL** button

⇒ If using a weighing container, put this before pressing the **PRINT** button. The taring process is automatically started. „0-t“ is displayed.



⇒ Confirm selected reference number of items by pressing the **PRINT** button.



⇒ Place as many pieces to add-up as required by the set reference piece number.

⇒ Acknowledge using **PRINT** button and wait for standstill control.  
After successful reference determination the current quantity is displayed.



⇒ Remove reference weight. The balance is now in parts counting mode counting all units on the weighing plate.



If it was impossible to determine a reference due to instable goods to be weighed or an insufficient reference weight, the following display will appear during reference calculation.

- **ERR04** = smallest counting weight not achieved
- **Add SMP**=if the placed quantity for a correct reference determination is too small, more parts must be placed as follows.

- ⇒ Place more parts, but at least the double quantity.
- ⇒ Press the **PRINT** button, the reference weight is calculated anew.

The placed quantity is always too small, add more parts and acknowledge using the **PRINT** button. Repeat the procedure until the piece counter display appears.

Placed quantity sufficient for reference determination. Remove reference weight. The balance is now in parts counting mode counting all units on the weighing plate.

### Return to weighing mode

- ⇒ Press the **ON/OFF** key.

### 10.1.1 Switching over between quantity and weight display

⇒ Place load on pan and read the number of pieces.

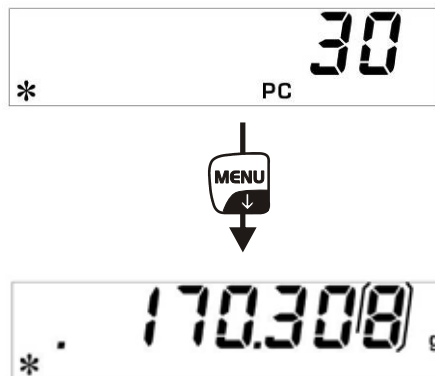

⇒ Press **MENU** button, the total weight of the placed parts is displayed.

**or**

⇒ Press the **MENU** button and keep it pressed until the acoustic signal gets mute, the average weight of a single piece is displayed.

⇒ Back to quantity display press **MENU** button again.

### 10.1.2 Automatic reference optimization

In order to improve the counting exactness, the reference can be optimised by adding more pieces. At every reference optimisation, the reference weight is calculated anew. As the additional pieces increase the base for the calculation, the reference also becomes more exact.

⇒ Leave the piece number on the weighing plate after setting the reference weight

⇒ Duplicate the number of pieces on the weighing plate and wait until the acoustic signal sounds. The reference weight is calculated anew.

⇒ Either repeat the reference optimisation by adding more pieces (max. 255 pieces) or start the counting process.



The automatic reference optimisation is not active when the reference weight is entered numerically.

### 10.1.3 Numeric entering of the reference weight

If you know the reference weight/piece you can enter this via the numeric keyboard.

⇒ In weighing mode press **MENU** button. The first menu item „count“ is displayed.



⇒ Acknowledge using **PRINT** button, the current reference quantity is displayed.



⇒ Press the arrow buttons ↓ ↑ to select the parameters manually.



⇒ Press the arrow buttons ↓ ↑ ← to enter the known reference weight.

⇒ If using a weighing container, put this before pressing the **PRINT** button. The taring process is automatically started. „0-t“ is displayed.

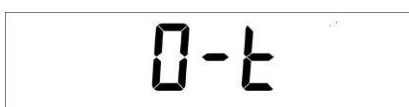

⇒ Place load on pan and read the number of pieces.



⇒ Press **MENU** button, the total weight of the placed parts is displayed.



⇒ Back to quantity display press **MENU** button again.

#### Return to weighing mode

⇒ Press the **ON/OFF** key



## 10.2 Density determination (Hydrostatic weighing)

Density is the relationship of weight [g] : volume [cm<sup>3</sup>]. The weight is determined by weighing the sample in air. The volume results from the ascending force [g] of the sample dipped in a liquid. The density [g/cm<sup>3</sup>] of that liquid is known (principle of Archimedes).

The density is determined with help of the underfloor weighing device.

### 10.2.1 Density determination of solids

Prepare the balance as follows:

- Switch off the balance
- Remove the weighing pan and carefully turn over the weighing balance.
- Screw-in hook for underfloor weighing (option)
- Place weighing balance over an opening
- Hook-in the sample support
- Fill measuring liquid in a vessel e.g. beaker) and temper it.

⇒ In weighing mode press **MENU** button. The first menu item „count“ is displayed.

⇒ Press **MENU** button

⇒ Acknowledge using **PRINT** button, the current setting is displayed.

⇒ Using **MENU** button select „d SoLid“

⇒ Confirm by pressing the **PRINT** button.

⇒ Use the arrow buttons ↓ ↑ ← to enter density of the measuring fluid.

⇒ Confirm input by pressing the **PRINT** button.

⇒ The display for weight determination of the "sample in air" appears.

A digital display showing the text "WE, Air" in a large, black, sans-serif font. The text is centered within a white rectangular border.

⇒ Confirm by pressing the **PRINT** button.

⇒ If necessary, tare and put the sample.

⇒ Wait until the weight display of the weighing balance has become stable and then press the **PRINT** button. „WEI AIR“ appears flashing.

⇒ The display for weight determination of the "sample in the measuring fluid" appears.

A digital display showing the text "WE, LIQ" in a large, black, sans-serif font. The text is centered within a white rectangular border.

⇒ Immerse sample holder and tare by pressing the **TARE**-key

⇒ Place sample and immerse it  
Make sure that the sample holder does not touch the beaker.

⇒ Wait until the weight display of the weighing balance has become stable and then press the **PRINT** button. „WEI LIQ“ appears flashing.

⇒ The density of the sample is shown

A digital display showing the density value "d 2.0000". The letter "d" is on the left, followed by a space and the number "2.0000". Below the number is the label "DS". The entire display is within a white rectangular border.

### Return to weighing mode

⇒ Press the **ON/OFF** key

A digital display showing the weight value "0.0000 g". The number "0.0000" is in the center, followed by a space and the letter "g". Below the number is the label "DS". The entire display is within a white rectangular border.

⇒ or use the **MENU** button to start a new measuring cycle.

If at the density determination errors have appeared, „d-----“, is displayed.

**i**

A digital display showing the text "d-----". The letter "d" is on the left, followed by a space and a series of seven dashes. Below the dashes is the label "DS". The entire display is within a white rectangular border.

## 10.2.2 Determining density of liquids

- ⇒ Fill sample liquid into a vessel, e.g. a pitcher.
- ⇒ Heat sample liquid until temperature is constant.
- ⇒ Prepare a glass sinker with known density
- ⇒ In weighing mode press **MENU** button. The first menu item „count“ is displayed.

A rectangular digital display showing the word "Count" in a black, monospaced font.

- ⇒ Press **MENU** button

A rectangular digital display showing "dEn5" in a black, monospaced font.

- ⇒ Acknowledge using **PRINT** button, the current setting is displayed.
- ⇒ Using **MENU** button select „d Liquid“

A rectangular digital display showing "dL 190 ld" in a black, monospaced font.

- ⇒ Confirm by pressing the **PRINT** button.

A rectangular digital display showing "d5 3.0000" in a black, monospaced font.

- ⇒ Use the arrow buttons **↓** **↑** **←** to enter density of the glass sinker.
- ⇒ Confirm input by pressing the **PRINT** button.

⇒ The display for weight determination of the "glass sinker in air" appears.

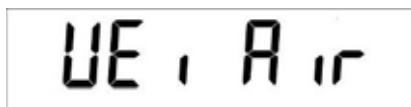

- ⇒ Confirm by pressing the **PRINT** button.
- ⇒ Tare if necessary and hook on the glass sinker centrally.
- ⇒ Wait until the weight display of the weighing balance has become stable and then press the **PRINT** button. „WEI AIR“ appears flashing.
- ⇒ The display for weight determination of the "glass sinker in sample liquid" appears.

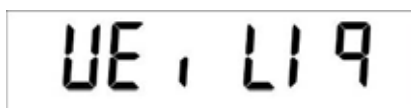

- ⇒ Tare if necessary and immerse the sinker into the measuring fluid
- ⇒ Wait until the weight display of the weighing balance has become stable and then press the **PRINT** button. „WEI LIQ“ appears flashing.
- ⇒ The density of the sample fluid is shown



### Return to weighing mode

⇒ Press the **ON/OFF** key



⇒ or use the **MENU** button to start a new measuring cycle.

If at the density determination errors have appeared, „d-----“, is displayed.

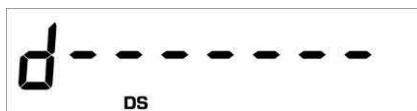

### 10.3 Checkweighing

An upper and a lower limit value can be established to ensure that the weighed goods are exactly within the established tolerance limits.

The display **[L]**, **[ok]** or **[H]** shows whether the goods to be weighed are within the two tolerance limits.



Goods to be weighed below tolerance limit

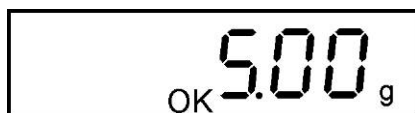

Goods to be weighed within tolerance range

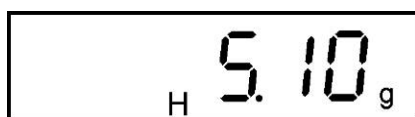

Goods to be weighed above tolerance limit

The indetermination if the goods to be weighed are within the tolerance limits, can additionally be given by an acoustic signal.

⇒ In weighing mode press **MENU** button. The first menu item „count“ is displayed.



⇒ Press **MENU** button repeatedly



⇒ Confirm using the **PRINT** button, the display to enter the lower tolerance limit appears.



⇒ Enter the lower limit value using the arrow buttons ↓ ↑ ←

⇒ Confirm using the **PRINT** button, the display to enter the upper tolerance limit appears.



⇒ Enter the upper limit value using the arrow buttons ↓ ↑ ←

⇒ Confirm using the **PRINT** button, the display to adjust the signal tone appears.

- ⇒ Select the desired settings by pressing the **MENU** button
  - Beep off**    Signal tone switched off
  - Beep on**    Signal tone on, if weighed goods are within tolerance range
- ⇒ Confirm by pressing the **PRINT** button.  
The balance is now in checkweighing mode.
- ⇒ Put on goods to be weighed, tolerance control is started

### **Return to weighing mode**

- ⇒ Press the **ON/OFF** key



## 10.4 Percent determination

Percent determination allows weight display in percent, in relation to a reference weight.

### 10.4.1 Entering the reference weight by weighing

⇒ In weighing mode press **MENU** button. The first menu item „count“ is displayed.

A rectangular digital display showing the word "Count" in a large, black, monospaced font.

⇒ Press **MENU** button repeatedly

A rectangular digital display showing the letters "PERC" in a large, black, monospaced font.

⇒ Acknowledge using **PRINT** button, the current setting is displayed.

⇒ Using **MENU** button select „PERC A“

A rectangular digital display showing the letters "PERC A" in a large, black, monospaced font.

⇒ If using a weighing container, put this before pressing the **PRINT** button. The taring process is automatically started. „0-t“ is displayed.

A rectangular digital display showing the characters "0-t" in a large, black, monospaced font.

A rectangular digital display showing the letters "LoAd" in a large, black, monospaced font.

⇒ Put on reference weight (=100 %)

⇒ Wait until the weight display of the balance has become stable and then press the **PRINT** button. The weight is adopted as reference (100%).

A rectangular digital display showing the number "100.00" with a small percentage symbol (%) below it, in a large, black, monospaced font.

⇒ Remove reference weight. From now the balance is in percent determining mode.

⇒ Place goods to be weighed on balance.  
The weight of the sample is displayed in percentage in terms of the reference weight.

## 10.4.2 Numeric entering of the reference weight

⇒ In weighing mode press **MENU** button. The first menu item „count“ is displayed.

The LCD display shows the word "Count" in a large, black, monospaced font.

⇒ Press **MENU** button repeatedly

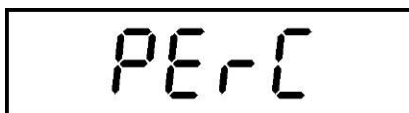
The LCD display shows the word "PERC" in a large, black, monospaced font.

⇒ Acknowledge using **PRINT** button, the current setting is displayed.

⇒ Using **MENU** button select „PERc n“

The LCD display shows "PERc n" in a large, black, monospaced font.

⇒ Confirm using the **PRINT** button, the display to enter the reference weight appears.

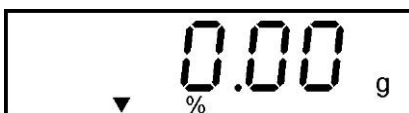
The LCD display shows "0.00 g" in a large, black, monospaced font. A small downward-pointing arrow is visible below the first zero.

⇒ Press the arrow buttons ↓ ↑ ← to enter the reference weight (100%).

⇒ Confirm input by pressing the **PRINT** button. From now the balance is in percent determining mode.

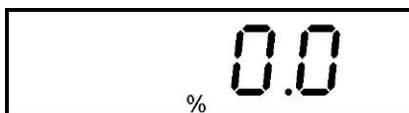
The LCD display shows "0.0 %" in a large, black, monospaced font.

⇒ Place goods to be weighed on balance.  
The weight of the sample is displayed in percentage in terms of the reference weight.

### Return to weighing mode

⇒ Press the **ON/OFF** key

The LCD display shows "0.0000 g" in a large, black, monospaced font. A small "\* O" is visible in the bottom left corner of the display area.

## 10.5 Peak value function

This function displays the highest load value (peak value) of a weighing. The peak value remains in the display until it will be deleted.

⇒ In weighing mode press **MENU** button. The first menu item „count“ is displayed.

A rectangular digital display showing the word "Count" in a large, black, monospace-style font.

⇒ Press **MENU** button repeatedly

A rectangular digital display showing "n Load" in a large, black, monospace-style font.

⇒ Confirm using **PRINT** button, the taring process is automatically started. „0-t“ is displayed.

From here the balance is in peak value mode, where a „M“ pops up.

A rectangular digital display showing "n 0.000 g" in a large, black, monospace-style font. To the left of the "n" is a small "M" character. Below the "n" is a small "\* O" symbol.

⇒ Load weighing plate. The maximum load value is displayed.

A rectangular digital display showing "n 68.984 g" in a large, black, monospace-style font. To the left of the "n" is a small "M" character. Below the "n" is a small "\*" symbol.

⇒ The peak value remains in the display until the **TARE** button is pressed. Then the balance is ready for further measurements.

### Return to weighing mode

⇒ Press the **ON/OFF** key

A rectangular digital display showing "0.000 g" in a large, black, monospace-style font. To the left of the "0" is a small "\* O" symbol.

## 11 Data output RS 232C

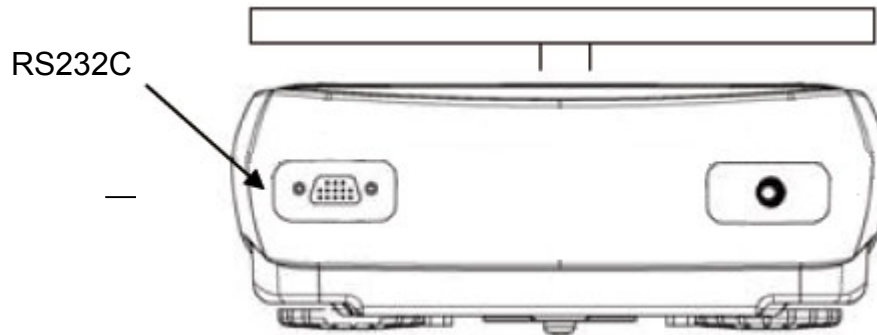

### 11.1 Technical Data

- 8-bit ASCII Code
- 8 data bits, 1 stop bit, no parity bit
- Baud rate optional from 1200 - 9600 Baud
- For operation with interface faultless operation is only ensured with the correct KERN – interface cable (max. 2m)

### 11.2 Pin allocation of balance output plug

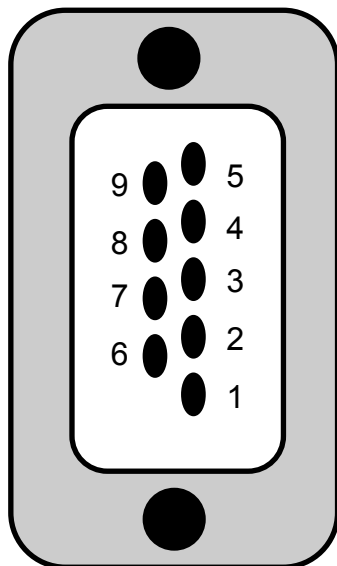

Pin 2: Tx Signal  
Pin 3: Rx Signal  
Pin 5: Gnd

### 11.3 Interface

- Balance – PC 25-pole

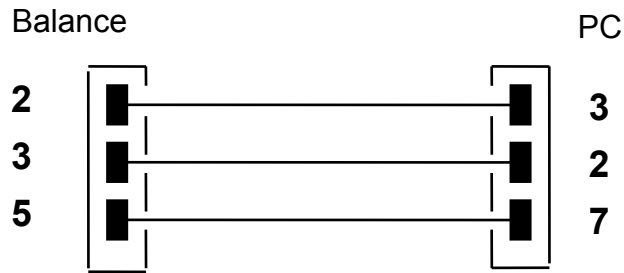

- Balance – PC 9-pole

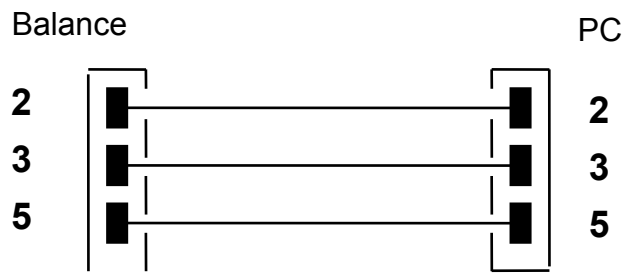

- Balance - printer

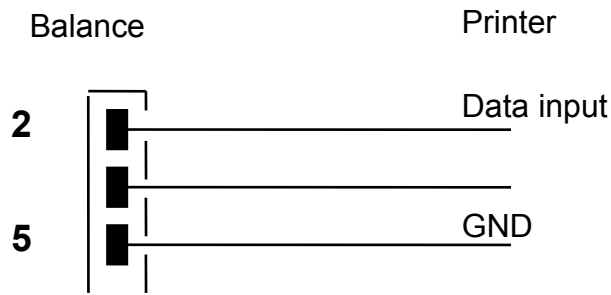

### 11.4 Data transfer

The data set consists of the following 14 characters:

|                  |                                |
|------------------|--------------------------------|
| 1. Character     | sign -/ blank (weighing value) |
| 2-9. Character   | weight or other data           |
| 10-12. Character | weighing unit                  |
| 13. Character    | stability display              |
| 14. Character    | carriage return                |
| 15. Character    | line feed                      |

## 11.5 Format for data transmission

At stable weight the format is transferred after pressing the **PRINT** button.

**Weighing mode** (continuous output and remote control command)

|           |        |    |    |    |    |    |    |               |     |     |           |     |     |      |
|-----------|--------|----|----|----|----|----|----|---------------|-----|-----|-----------|-----|-----|------|
| 1°        | 2°     | 3° | 4° | 5° | 6° | 7° | 8° | 9°            | 10° | 11° | 12°       | 13° | 14° | 15°r |
| Character | Weight |    |    |    |    |    |    | Weighing unit |     |     | Stability | CR  | LF  |      |

**Density determination** (only remote control command)

|    |    |         |    |    |    |    |       |               |     |     |     |     |     |     |     |     |
|----|----|---------|----|----|----|----|-------|---------------|-----|-----|-----|-----|-----|-----|-----|-----|
| 1° | 2° | 3°      | 4° | 5° | 6° | 7° | 8°    | 9°            | 10° | 11° | 12° | 13° | 14° | 15° | 16° | 17° |
| d  | =  | Density |    |    |    |    | Blank | Weighing unit |     |     |     |     | CR  | LF  |     |     |

**Counting** (only remote control command)

Number of pieces

|     |    |    |       |    |    |    |          |    |     |     |     |     |     |     |     |
|-----|----|----|-------|----|----|----|----------|----|-----|-----|-----|-----|-----|-----|-----|
| 1°  | 2° | 3° | 4°    | 5° | 6° | 7° | 8°       | 9° | 10° | 11° | 12° | 13° | 14° | 15° | 16° |
| Pcs |    | :  | Blank |    |    |    | Quantity |    |     |     |     |     |     |     |     |

Weight of placed pieces

|        |    |    |    |    |    |    |       |                 |     |     |     |     |     |       |     |       |     |     |     |
|--------|----|----|----|----|----|----|-------|-----------------|-----|-----|-----|-----|-----|-------|-----|-------|-----|-----|-----|
| 1°     | 2° | 3° | 4° | 5° | 6° | 7° | 8°    | 9°              | 10° | 11° | 12° | 13° | 14° | 15°   | 16° | 17°   | 18° | 19° | 20° |
| Weight |    |    |    |    |    | :  | space | Measuring Value |     |     |     |     |     | space | g   | space | S   |     |     |

Average parts weight

|                                |    |    |       |    |    |    |                 |    |     |     |     |     |     |       |     |     |     |
|--------------------------------|----|----|-------|----|----|----|-----------------|----|-----|-----|-----|-----|-----|-------|-----|-----|-----|
| 1°                             | 2° | 3° | 4°    | 5° | 6° | 7° | 8°              | 9° | 10° | 11° | 12° | 13° | 14° | 15°   | 16° | 17° | 18° |
| PMU<br>average piece<br>weight |    | :  | Blank |    |    |    | Measuring Value |    |     |     |     |     |     | space | g   |     |     |

## 11.6 Remote control instructions

| Instruction: | Function   |
|--------------|------------|
| "T" = H54    | Taring     |
| "C" = H43    | Adjustment |
| "E" = H45    | Enter      |
| "M" = H4D    | Menu       |
| "O" = H4F    | ON/OFF     |

## 11.7 Printer mode

The following conditions must be met to provide successful communication between the weighing balance and the printer.

- Use a suitable cable to connect the weighing balance to the interface of the printer. Faultless operation requires an adequate KERN interface cable.
- The Baud rates of balance and printer must agree, see chap. 9.3.

## Printout examples:

### Weighing mode/peak value function

|       |          |
|-------|----------|
| ..... | 22.000 g |
|-------|----------|

### Density determination

|                              |
|------------------------------|
| d= 2.80066 g/cm <sup>3</sup> |
|------------------------------|

d            Measuring value „Density“

### Parts counting

|         |           |
|---------|-----------|
| Pcs     | 100       |
| Weight: | 300.000 g |
| PMU:    | 3.000 g   |

PCS            Number of pieces

Weight        Weight of placed pieces

PMU            Average parts weight



### Percent determination

|         |          |
|---------|----------|
| Perc.   | 20 %     |
| Weight: | 30.000 g |

Perc            Display value in [%]

Weight        Display value in [g]

## 12 Error messages

|  |  |
|--|--|
| ERR01  | Weight value instable or zeroing not possible. Check the environmental conditions.             |
| ERR02  | Adjustment error, e.g. environmental conditions instable                                       |
| ERR03  | Adjustment error e.g. incorrect adjustment weight}   |
| ERR04  | Piece weight too small/instable  |
| ERR05  | Data transfer not possible, as weighing value is instable. Check the environmental conditions. |
| ERR06  | Weighing value in density determining mode instable. Check the environmental conditions.       |
| “UNLOAD”:  | Weighing range not achieved.<br>Check position of the weighing plate                           |
| “CAL But”  | Adjust balance   |
|   | Weighing range exceeded, placed load exceeds the capacity of the balance. Unload the balance.  |
|  | Weighing range not reached, e.g. weighing plate not in place                                   |

## 13 Service, maintenance, disposal

### 13.1 Cleaning

Before cleaning, please disconnect the appliance from the operating voltage.

Please do not use aggressive cleaning agents (solvents or similar agents), but a cloth dampened with mild soap suds. Ensure that no liquid penetrates into the device and wipe with a dry soft cloth.

Loose residue sample/powder can be removed carefully with a brush or manual vacuum cleaner.

**Spilled weighing goods must be removed immediately.**

### 13.2 Service, maintenance

The appliance may only be opened by trained service technicians who are authorized by KERN.

Before opening, disconnect from power supply.

### 13.3 Disposal

Disposal of packaging and appliance must be carried out by operator according to valid national or regional law of the location where the appliance is used.

## 14 Instant help

In case of an error in the program process, briefly turn off the balance and disconnect from power supply. The weighing process must then be restarted from the beginning.

Help:

### Fault

### Possible cause

The displayed weight does not glow.

- The balance is not switched on.
- The mains supply connection has been interrupted (mains cable not plugged in/faulty).
- Power supply interrupted.
- (Rechargeable) batteries are inserted incorrectly or empty
- No (rechargeable) batteries inserted.

The displayed weight is permanently changing

- Draught/air movement
- Table/floor vibrations
- Weighing plate has contact with other objects.
- Electromagnetic fields / static charging (choose different location/switch off interfering device if possible)

The weighing result is obviously incorrect

- The display of the balance is not at zero
- Adjustment is no longer correct.
- Great fluctuations in temperature.
- Warm-up time was ignored.
- Electromagnetic fields / static charging (choose different location/switch off interfering device if possible)

Should other error messages occur, switch balance off and then on again. If the error message remains inform manufacturer.